

1

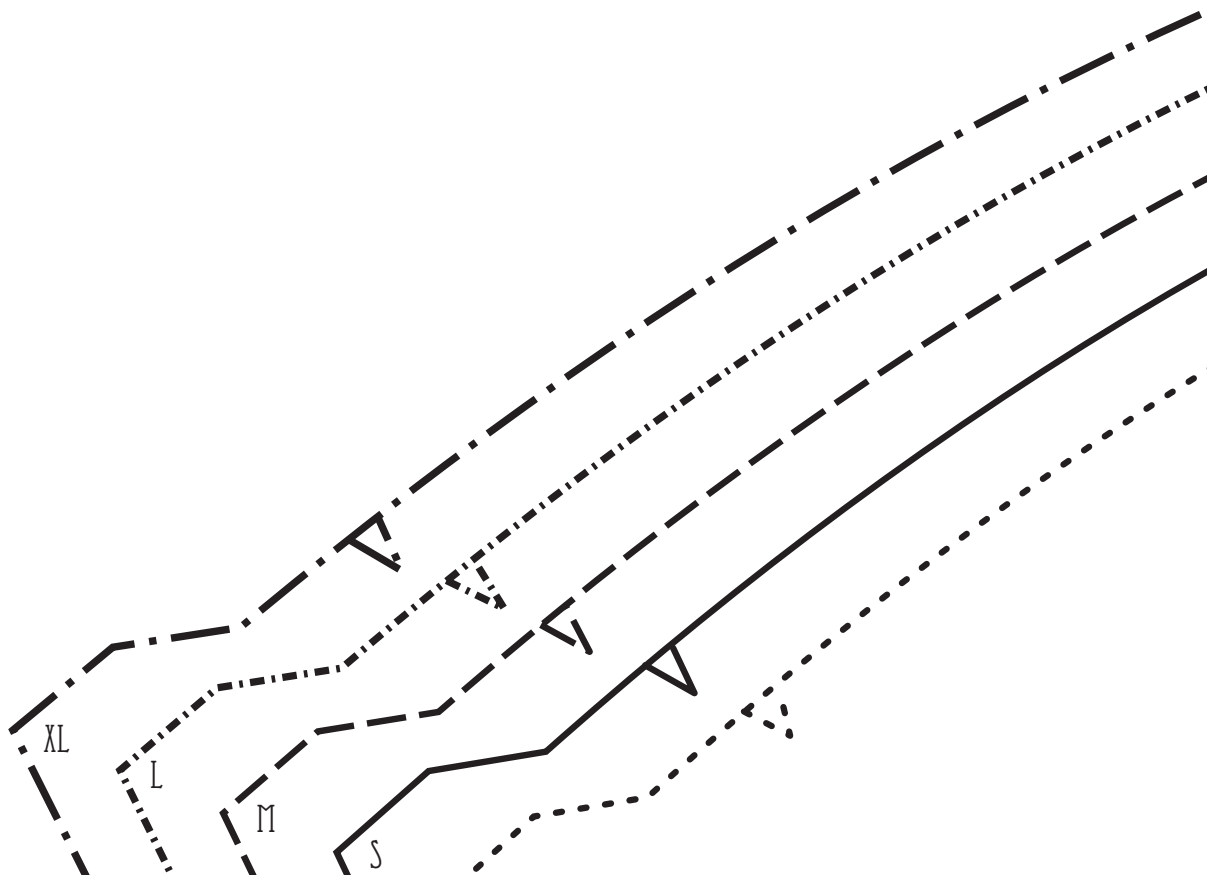

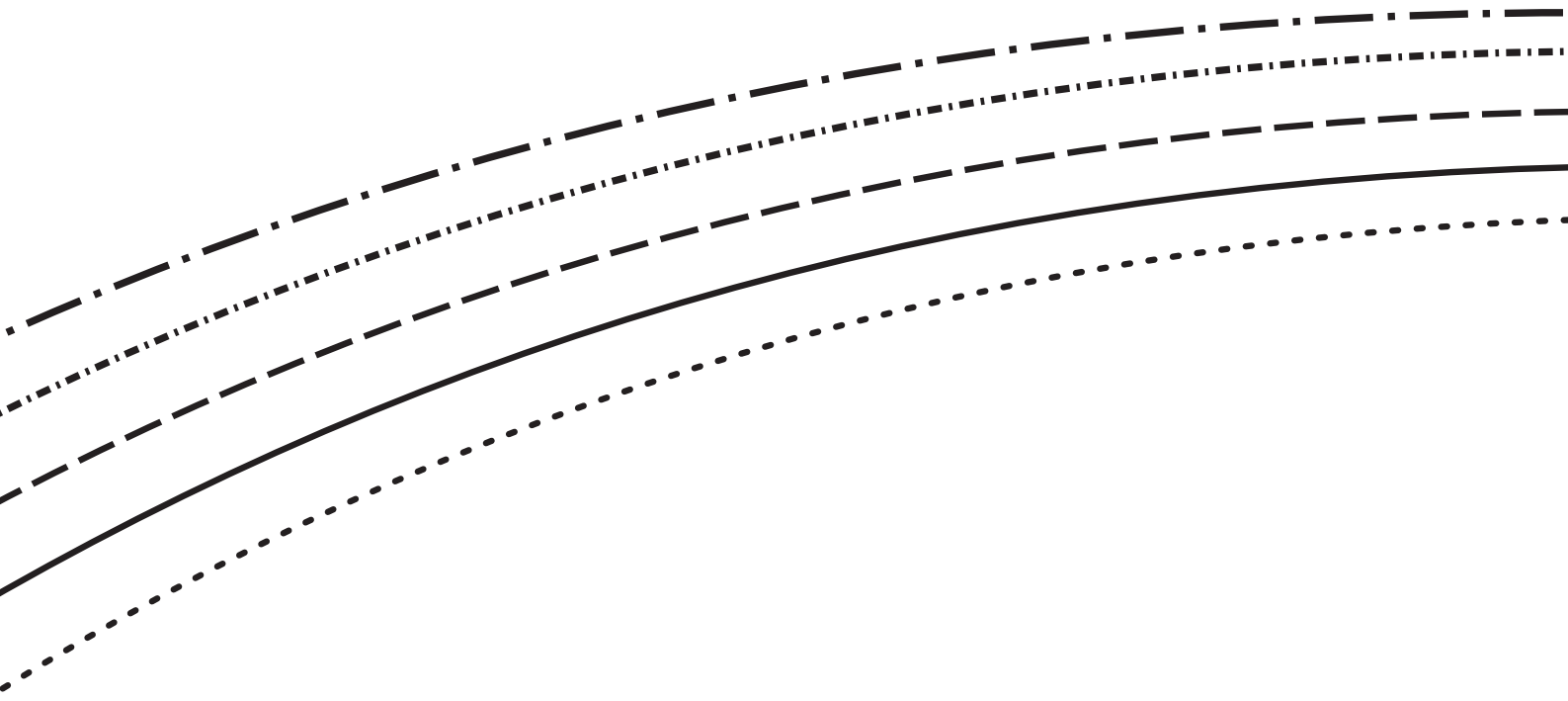

A TANIT-ISIS PA

THE OBSERVATIONS

3

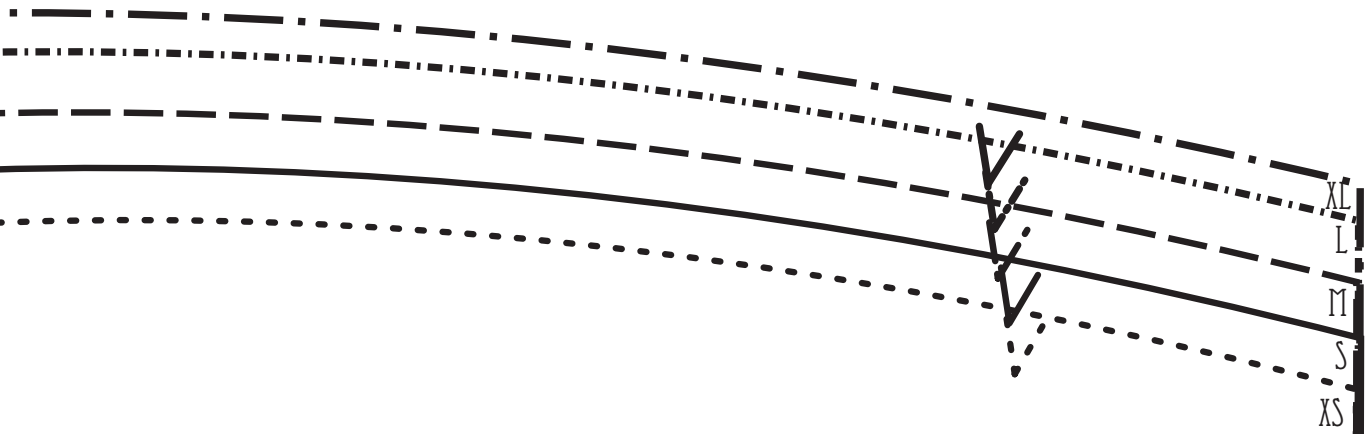

XL
L
M
S
XS

PATTERN

SHIRT FRONT

4

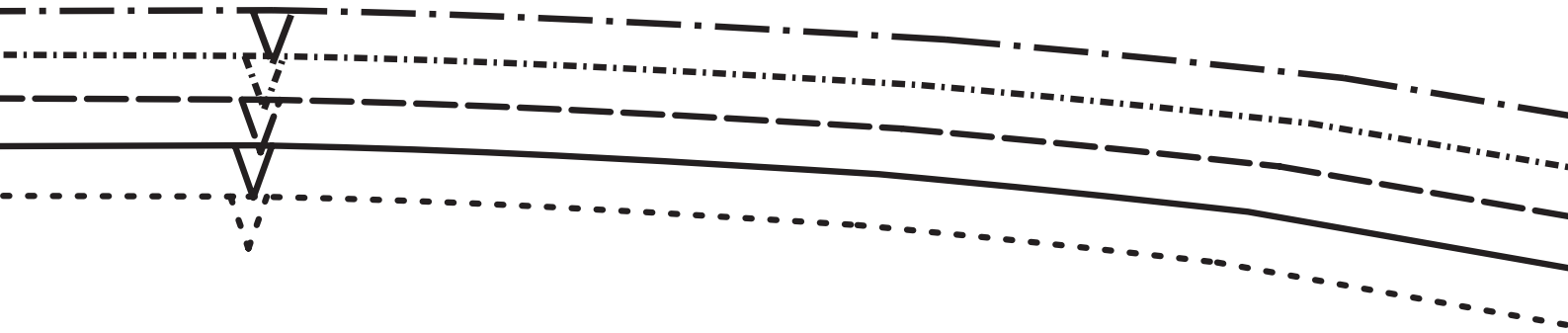

A TANIT-ISI

5

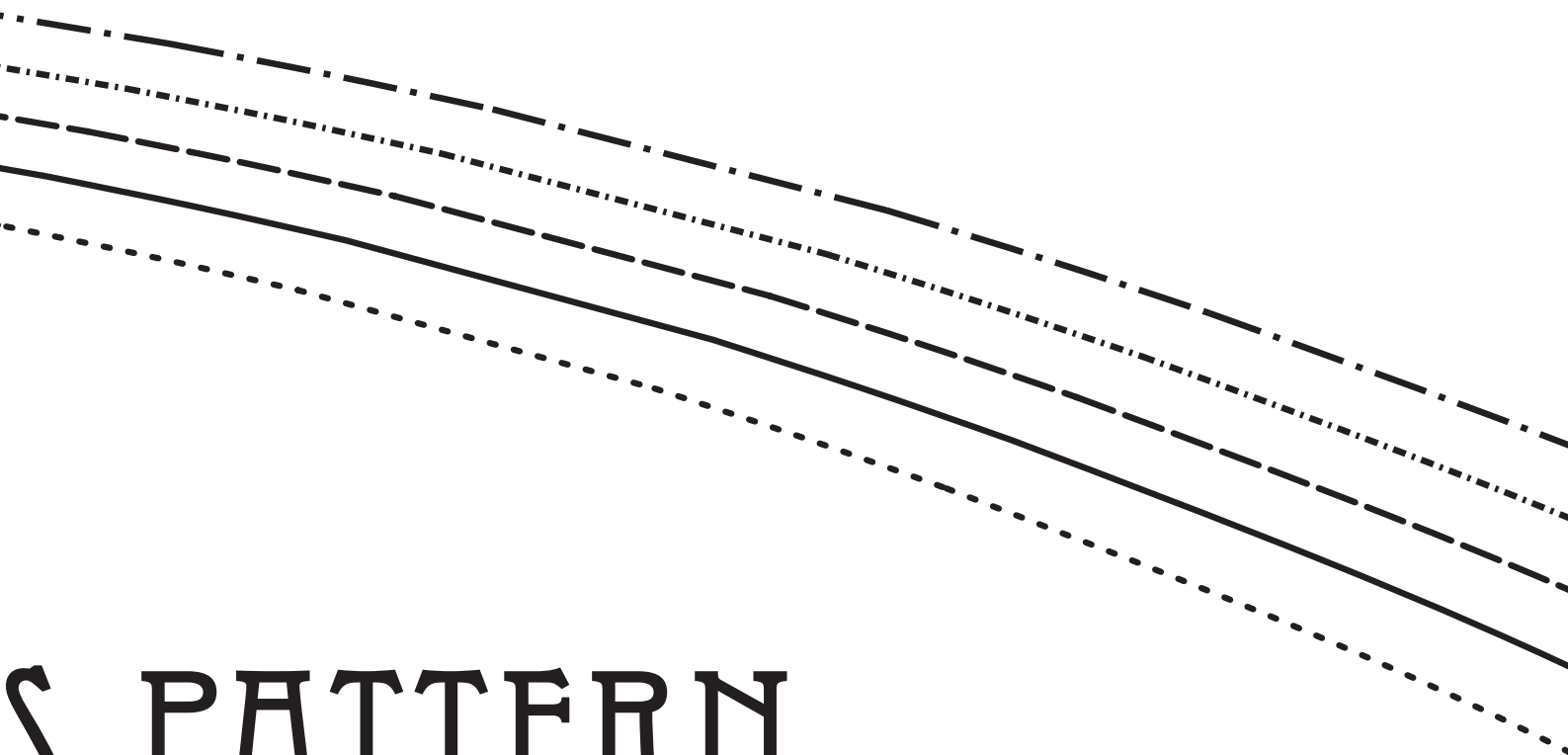

S PATTERN

6

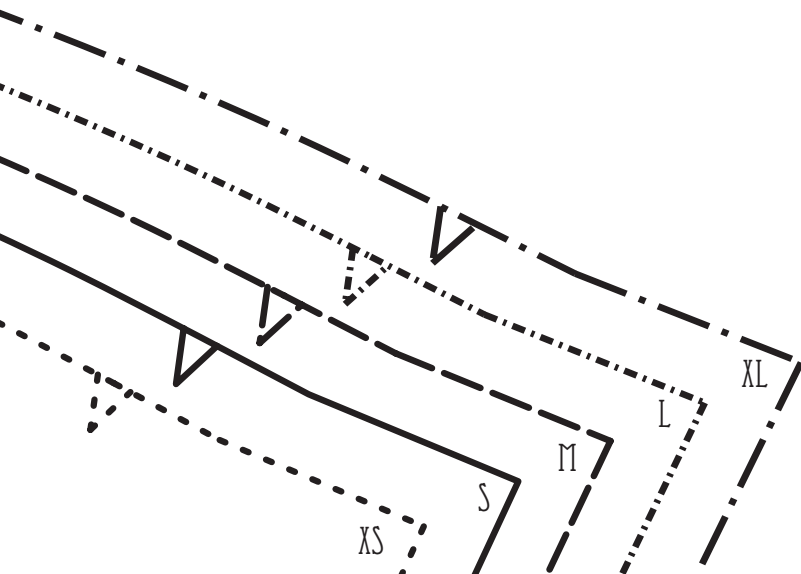

7

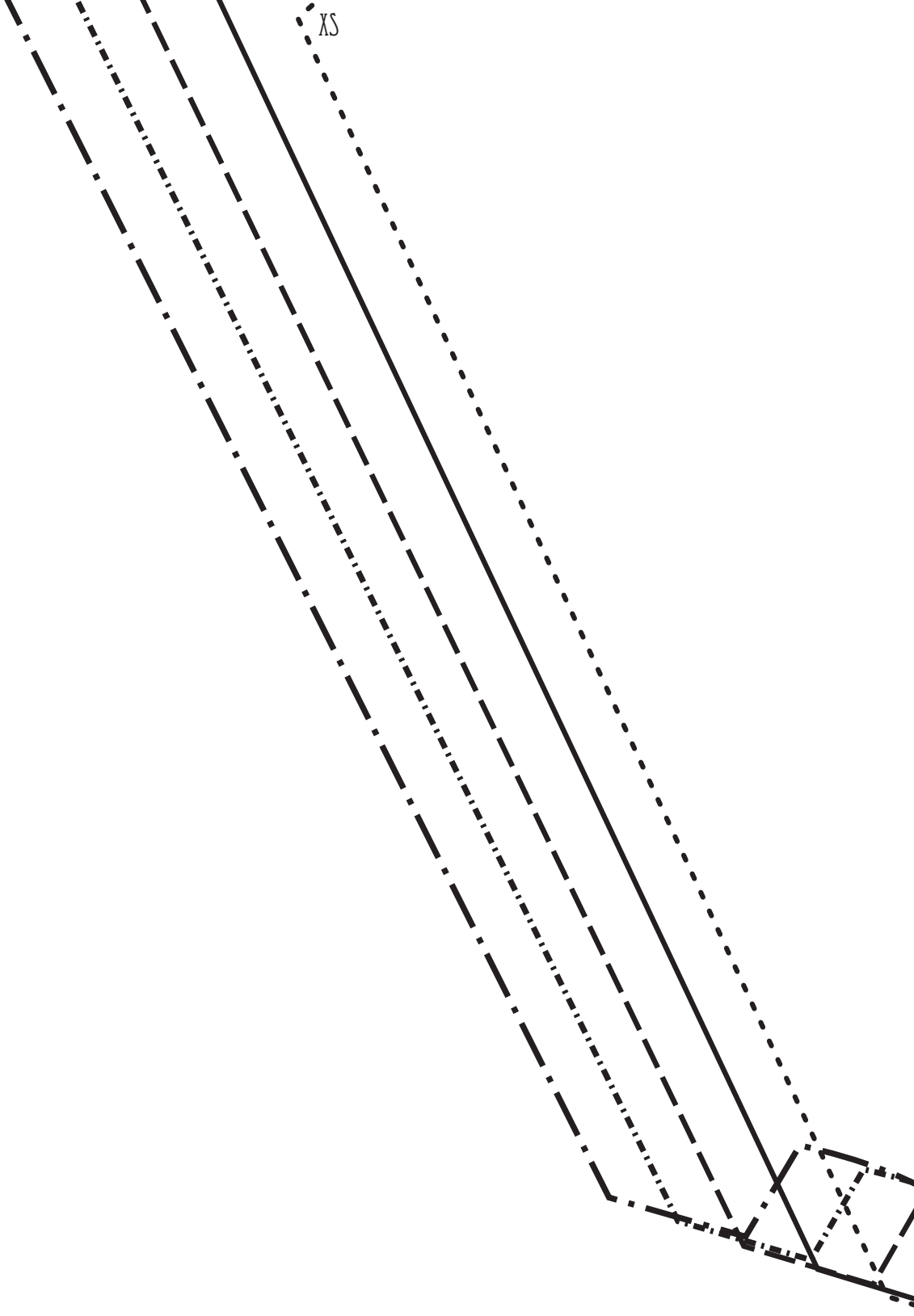

THE GRECIAN S

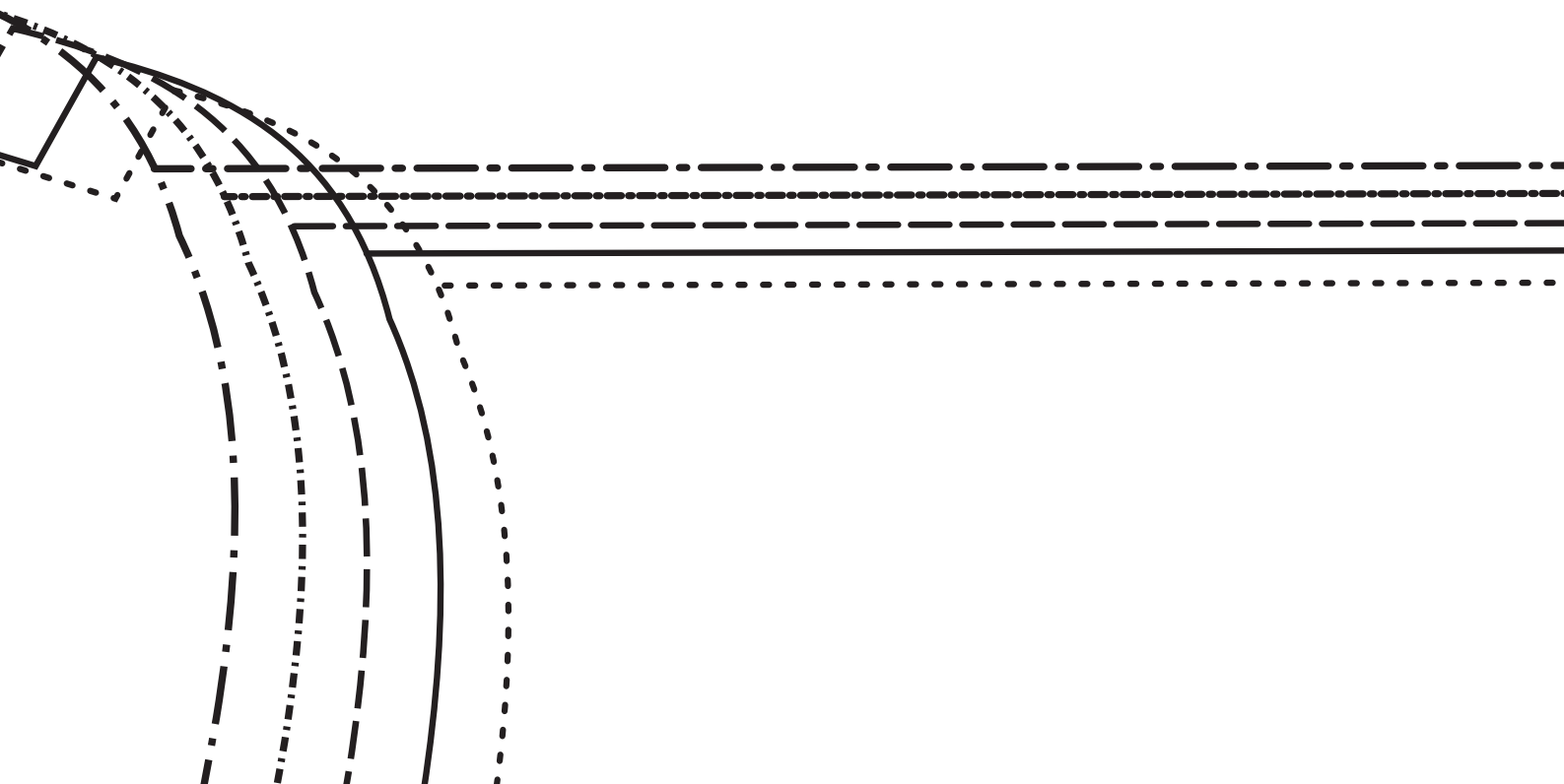

ADDRESS



XL
L
M
S
XS



10

THE GRECIAN



XL
L
M
S
XS



TANITISIS. WORDPRESS

MY SUNDRESS

RESS.COM

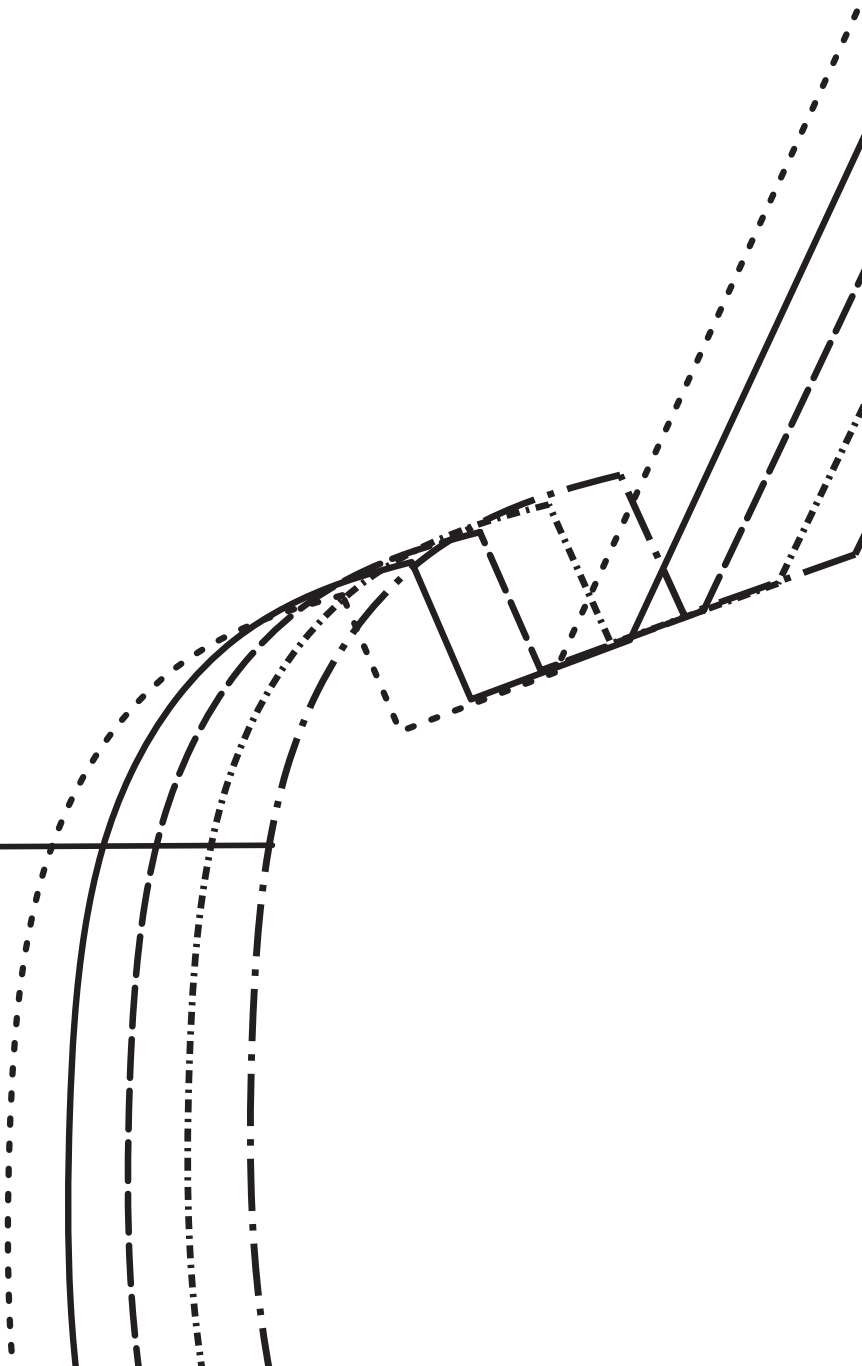

12

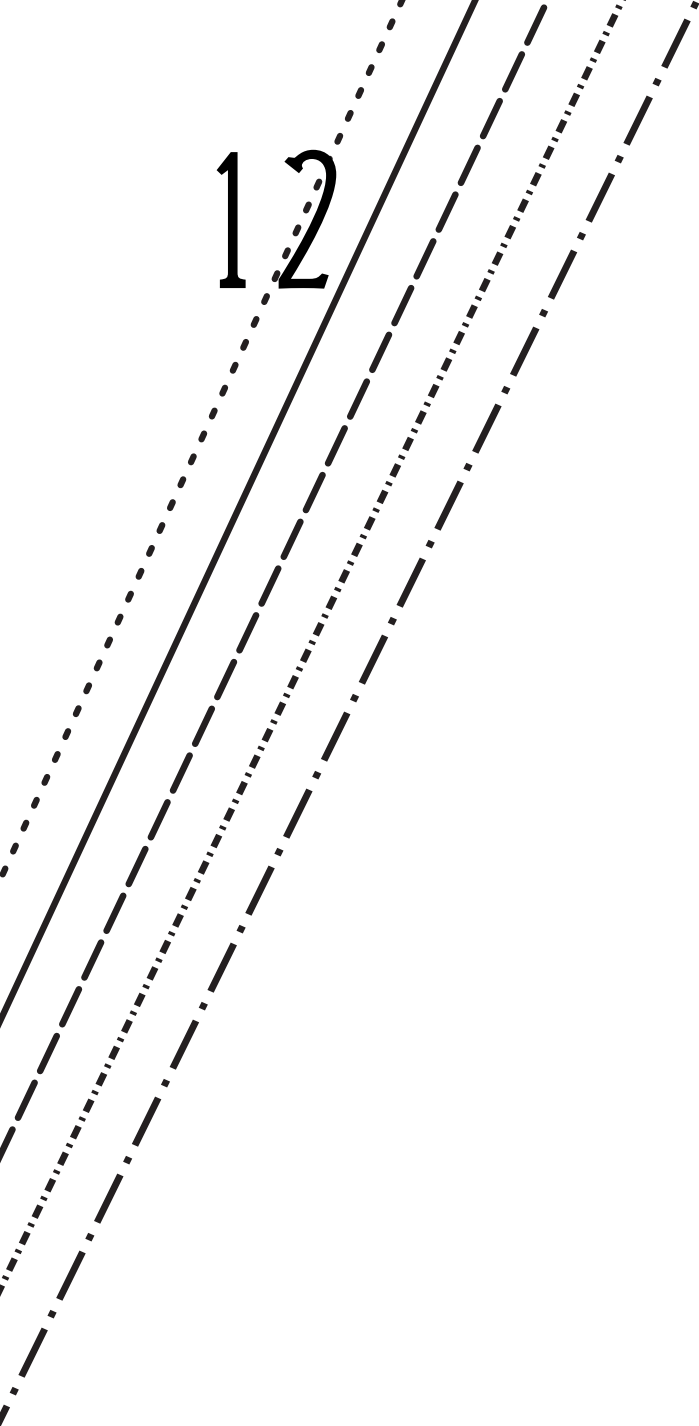

13

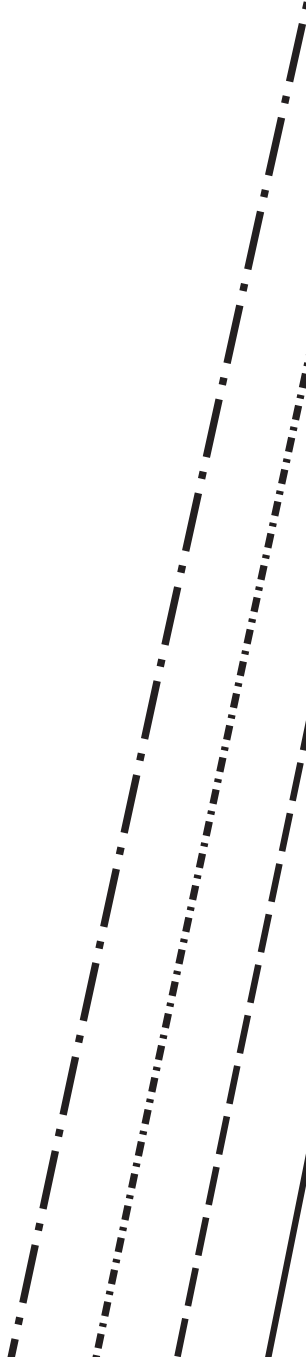



1 4

FRONT

CUT 2

15

16

10

17

BACK CUT 2

CM SQUARE

4" X 4"

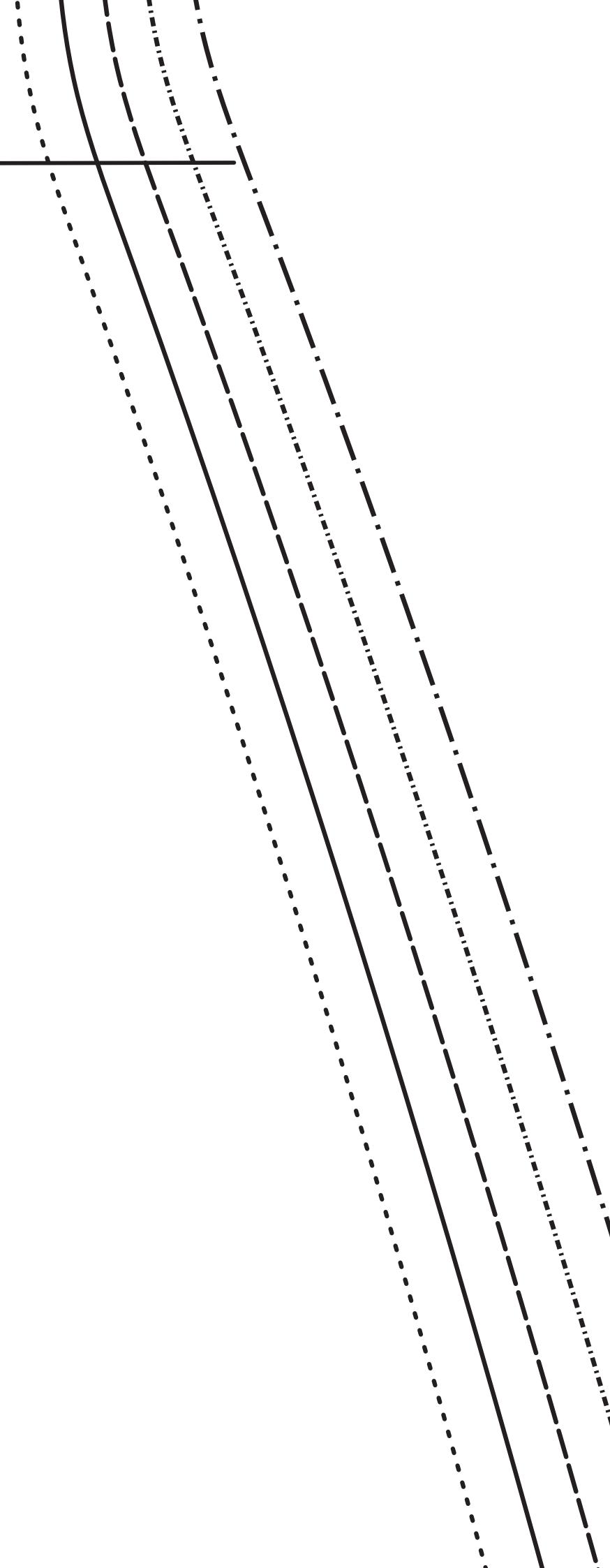

10

19

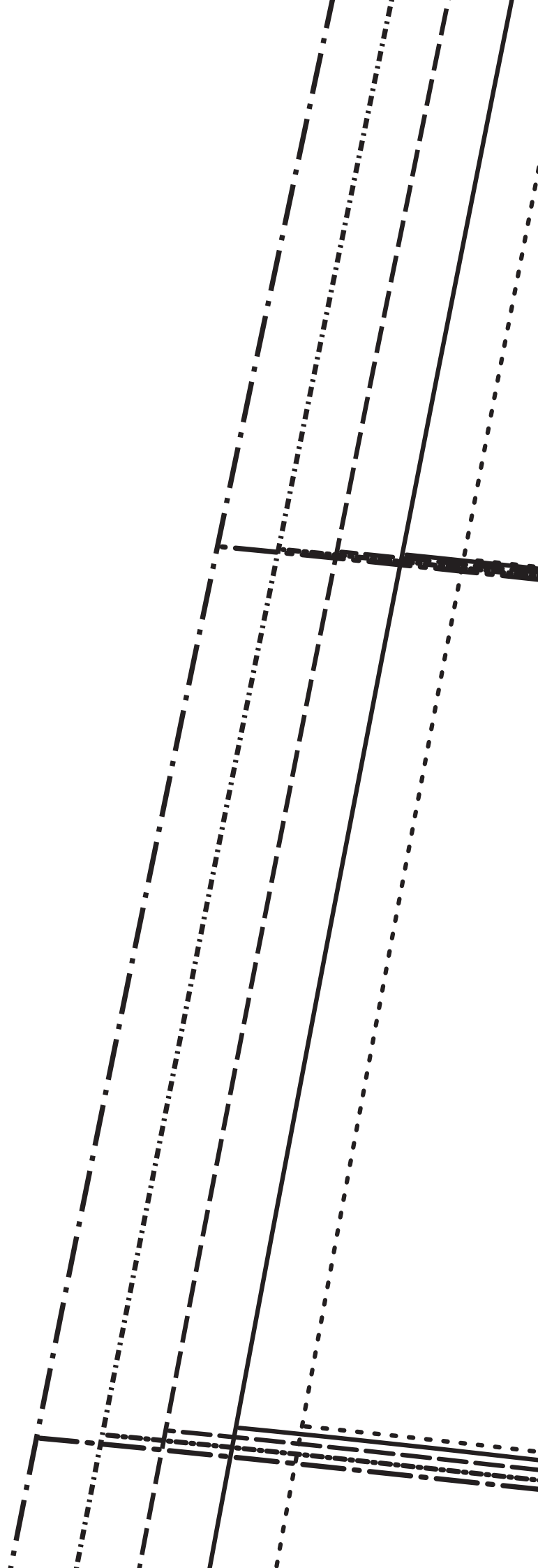

20

TUN

KI

21

MIC-LENGTH CUTTING LINE

NEE-LENGTH CUTTING LINE

22

TUNIC-LENGTH CUTTING LINE

KNEE-LENGTH CUTTING LINE

23

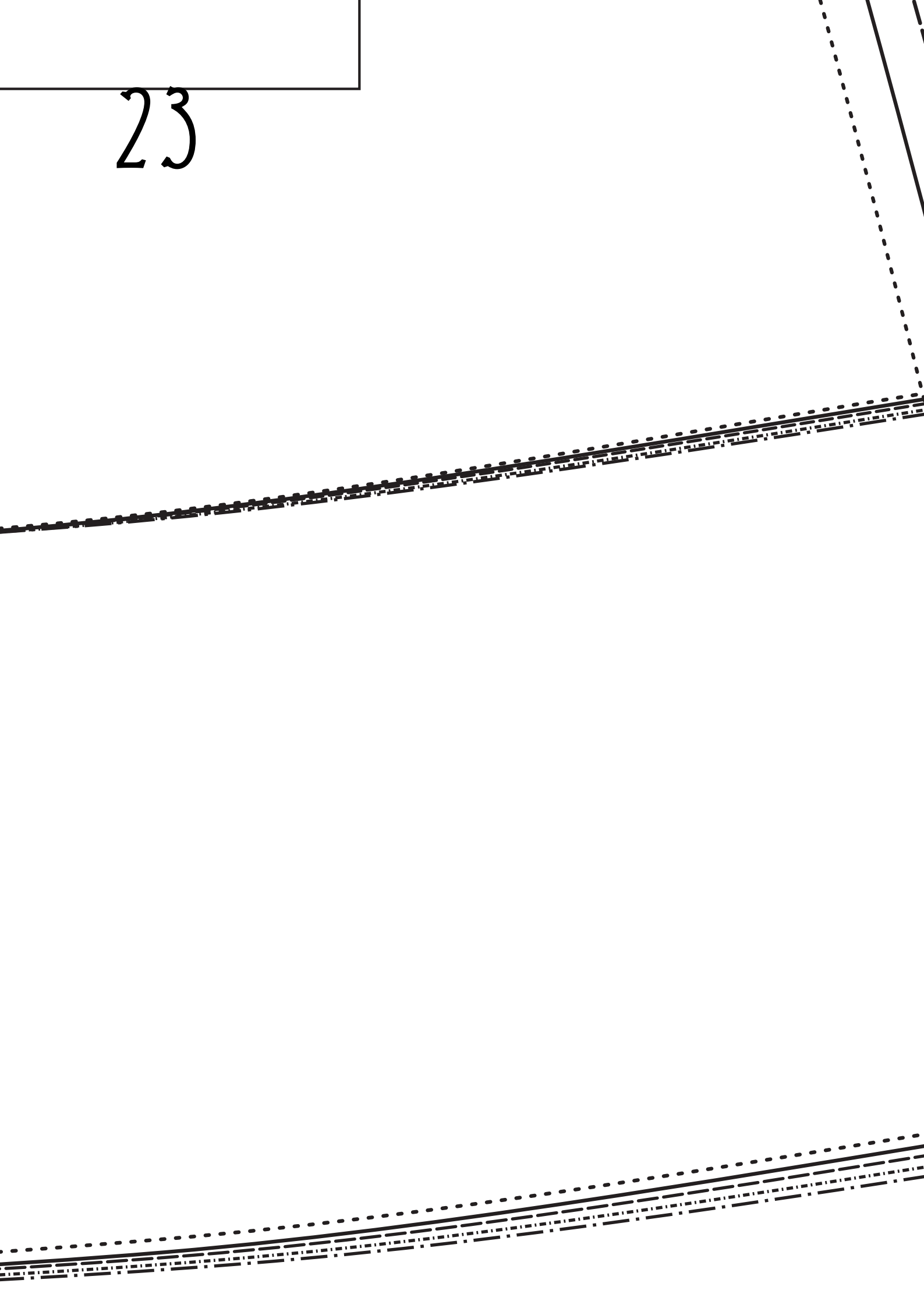

24

25

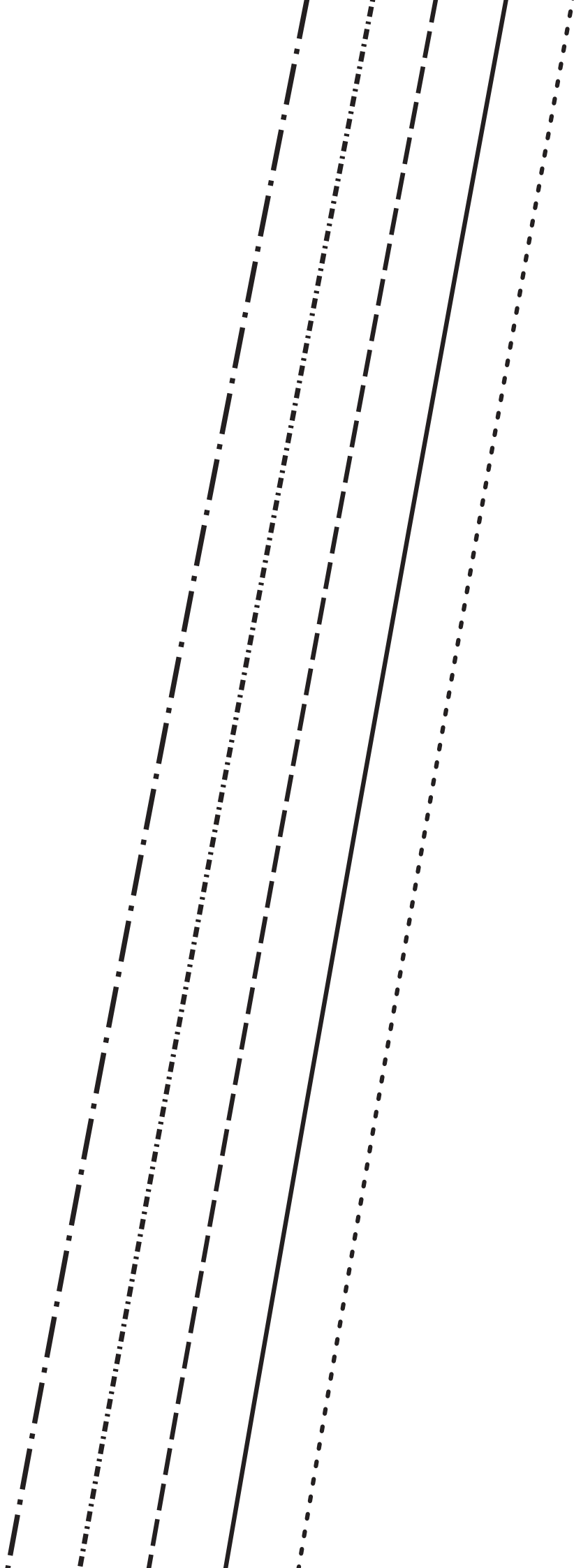

26

27

20

29

30

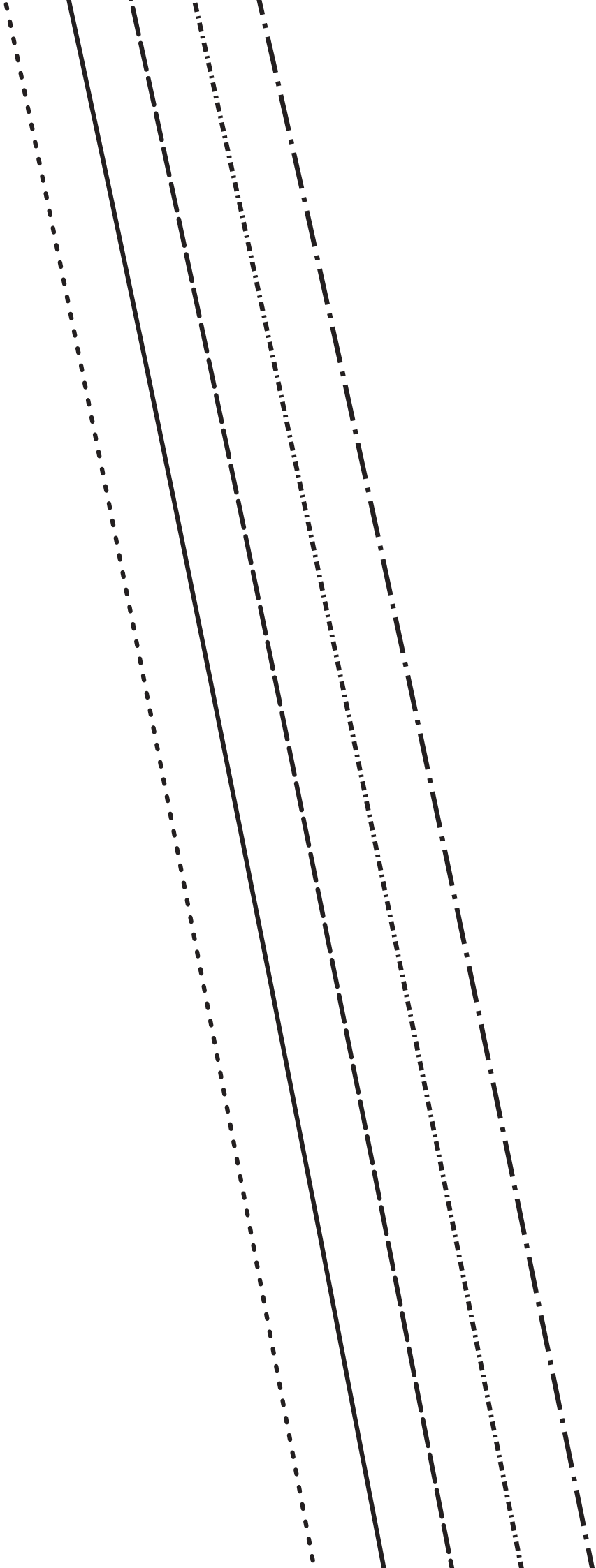

31

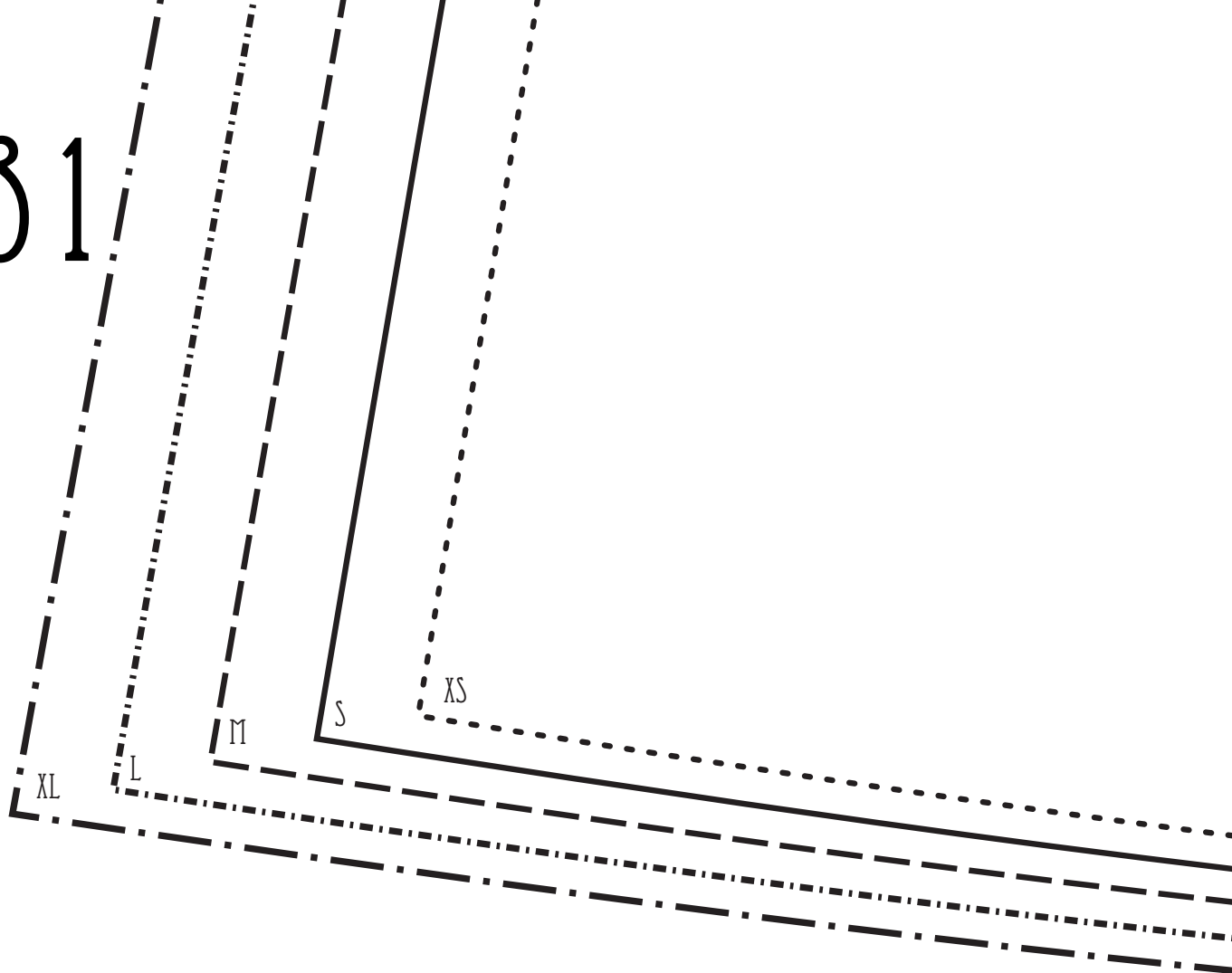

32

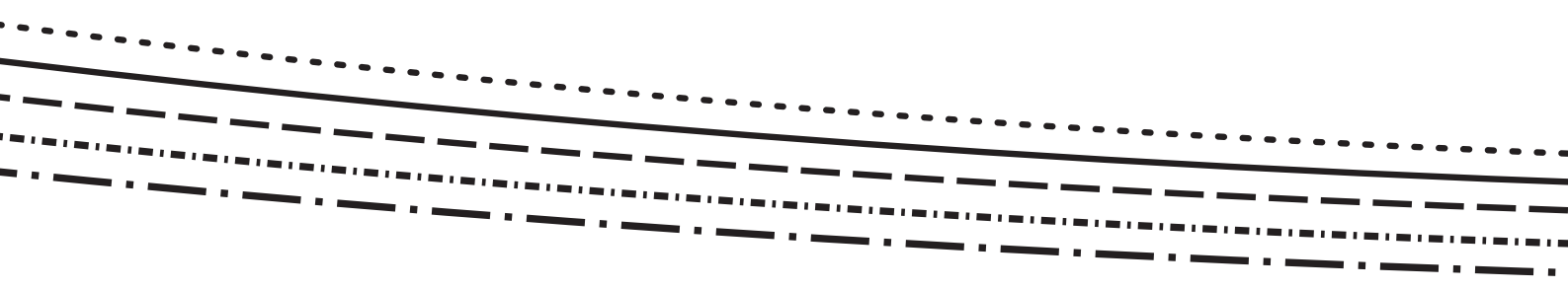

33



34



35

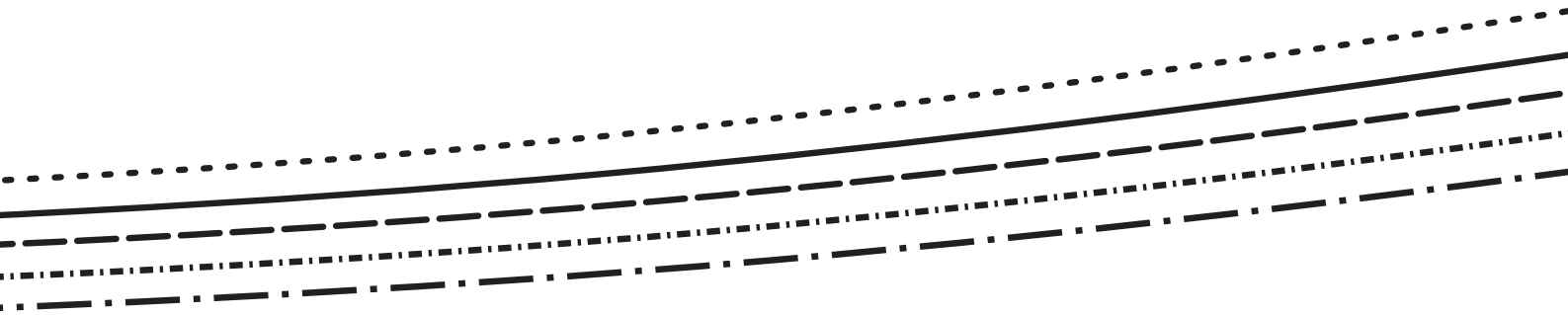

36

